

OMRON®

INSTRUCTION MANUAL

3 Series Upper Arm Blood Pressure Monitor

Model BP7100CAN



All for Healthcare

ENGLISH

Table of Contents

Introduction	3
Important Safety Information	4
1. Know Your Monitor	8
2. Preparation	13
3. Using the Monitor	14
4. Error Messages and Troubleshooting	20
5. Maintenance	23
6. Specifications	25
7. FCC/ISED Statement	27
8. Limited Warranty	28
9. Guidance and Manufacturer's Declaration	30

Introduction

Thank you for purchasing the OMRON BP7100CAN Blood Pressure Monitor. This blood pressure monitor uses the oscillometric method of blood pressure measurement. This means this monitor detects your blood movement through your brachial artery and converts the movements into a digital reading.

Safety Instructions

This instruction manual provides you with important information about the OMRON BP7100CAN Blood Pressure Monitor. To ensure the safe and proper use of this monitor, READ and UNDERSTAND all of these instructions. **If you do not understand these instructions or have any questions, contact 1-800-634-4350 before attempting to use this monitor. For specific information about your own blood pressure, consult with your physician.**

Intended Use

This device is a digital monitor intended for use in measuring blood pressure and pulse rate in adult patient population. The device detects the appearance of irregular heartbeats during measurement and gives a warning signal with readings.

Environments of Use: Home

Patient Population: Adult

Receiving and Inspection

Remove this monitor from the packaging and inspect for damage. If this monitor is damaged, DO NOT USE and contact 1-800-634-4350.

Symbols Glossary

For symbol information, visit:

OmronHealthcare.ca/symbols-glossary

Contraindications

- This monitor is contraindicated for use in ambulatory environments.
 - This monitor is contraindicated for use on aircraft.
-

Important Safety Information

Read the Important Safety Information in this instruction manual before using this monitor.

Follow this instruction manual thoroughly for your safety.

Keep for future reference. For specific information about your own blood pressure, CONSULT WITH YOUR PHYSICIAN.



Warning

Indicates a potentially hazardous situation which, if not avoided, could result in death or serious injury.

- **DO NOT use this monitor on infants, toddlers, children or persons who cannot express themselves.**
- **DO NOT adjust medication based on readings from this blood pressure monitor. Take medication as prescribed by your physician. ONLY a physician is qualified to diagnose and treat high blood pressure.**
- **DO NOT use this monitor on an injured arm or an arm under medical treatment.**
- **DO NOT apply the arm cuff on your arm while on an intravenous drip or blood transfusion.**
- **DO NOT use this monitor in areas containing high frequency (HF) surgical equipment, magnetic resonance imaging (MRI) equipment, computerized tomography (CT) scanners or in oxygen rich environments. This may result in incorrect operation of the monitor and/or cause an inaccurate reading.**
- **DO NOT use this monitor in oxygen rich environments or near flammable gas.**
- **Consult with your physician before using this monitor if you have common arrhythmias such as atrial or ventricular premature beats or atrial fibrillation; arterial sclerosis; poor perfusion; diabetes; pregnancy; pre-eclampsia or renal disease. NOTE that any of these conditions in addition to patient motion, trembling, or shivering may affect the measurement reading.**
- **NEVER diagnose or treat yourself based on your readings. ALWAYS consult with your physician.**
- **To help avoid strangulation, keep the air tube away from infants, toddlers and children.**

- This product contains small parts that may cause a choking hazard if swallowed by infants, toddlers and children.

Battery Handling and Usage

- Keep batteries out of the reach of infants, toddlers and children.



Indicates a potentially hazardous situation which, if not avoided, may result in minor or moderate injury to the user or patient, or cause damage to the equipment or other property.

- Stop using this monitor and consult with your physician if you experience skin irritation or discomfort.
- Consult with your physician before using this monitor on an arm where intravascular access or therapy, or an arteriovenous (A-V) shunt, is present because of temporary interference to blood flow which could result in injury.
- Consult with your physician before using this monitor if you have had a mastectomy.
- Consult with your physician before using this monitor if you have severe blood flow problems or blood disorders as cuff inflation can cause bruising.
- DO NOT take measurements more often than necessary because bruising, due to blood flow interference, may occur.
- ONLY inflate the arm cuff when it is applied on your upper arm.
- Remove the arm cuff if it does not start deflating during a measurement.
- DO NOT use this monitor for any purpose other than measuring blood pressure.
- During measurement, make sure that no mobile device or any other electrical device that emits electromagnetic fields is within 12 inches (30 cm) of this monitor. This may result in incorrect operation of the monitor and/or cause an inaccurate reading.
- DO NOT disassemble or attempt to repair this monitor or other components. This may cause an inaccurate reading.
- DO NOT use in a location where there is moisture or a risk of water splashing this monitor. This may damage this monitor.
- DO NOT use this monitor in a moving vehicle such as in a car.
- DO NOT drop or subject this monitor to strong shocks or vibrations.

- **DO NOT** use this monitor in places with high or low humidity or high or low temperatures. Refer to section 5.
- During measurement, observe the arm to ensure that the monitor is not causing prolonged impairment to blood circulation.
- **DO NOT** use this monitor in high-use environments such as medical clinics or physician offices.
- **DO NOT** use this monitor with other medical electrical (ME) equipment simultaneously. This may result in incorrect operation of the monitor and/or cause an inaccurate reading.
- Avoid bathing, drinking alcohol or caffeine, smoking, exercising and eating for at least 30 minutes before taking a measurement.
- Rest for at least 5 minutes before taking a measurement.
- Remove tight-fitting or thick clothing from your arm while taking a measurement.
- Remain still and **DO NOT** talk while taking a measurement.
- **ONLY** use the arm cuff on persons whose arm circumference is within the specified range of the cuff.
- Ensure that this monitor has acclimated to room temperature before taking a measurement. Taking a measurement after an extreme temperature change could lead to an inaccurate reading. OMRON recommends waiting for approximately 2 hours for the monitor to warm up or cool down when the monitor is used in an environment within the temperature specified as operating conditions after it is stored either at the maximum or at the minimum storage temperature. For additional information on operating and storage/transport temperature, refer to section 5.
- **DO NOT** use this monitor after the durable period has ended. Refer to section 6.
- **DO NOT** crease the arm cuff or the air tube excessively.
- **DO NOT** fold or kink the air tube while taking a measurement. This may cause an injury by interrupting air flow.
- To unplug the air plug, pull on the plastic air plug at the base of the tube, not the tube itself.
- **ONLY** use the arm cuff, batteries and accessories specified for this monitor. Use of unsupported arm cuffs and batteries may damage and/or may be hazardous to this monitor.
- **ONLY** use the approved arm cuff for this monitor. Use of other arm cuffs may result in incorrect readings.

- Inflating to a higher pressure than necessary may result in bruising of the arm where the cuff is applied. NOTE: please refer to “If your systolic pressure is more than 210 mmHg” in section 3 of this instruction manual for additional information.

Battery Handling and Usage

- DO NOT insert batteries with their polarities incorrectly aligned.
- ONLY use 4 “AA” alkaline or manganese batteries with this monitor. DO NOT use other types of batteries. DO NOT use new and used batteries together. DO NOT use different brands of batteries together.
- Remove batteries if this monitor will not be used for a long period of time.
- If battery fluid should get in your eyes, immediately rinse with plenty of clean water. Consult with your physician immediately.
- If battery fluid should get on your skin, wash your skin immediately with plenty of clean, lukewarm water. If irritation, injury or pain persists, consult with your physician.
- DO NOT use batteries after their expiration date.
- Periodically check batteries to ensure they are in good working condition.

1. Know Your Monitor

Contents:

Monitor, arm cuff, instruction manual, quick start guide

Monitor:

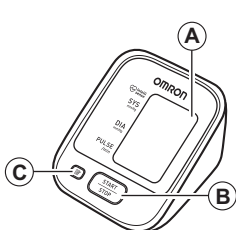

- Ⓐ Display
- Ⓑ START/STOP button
- Ⓒ Memory button

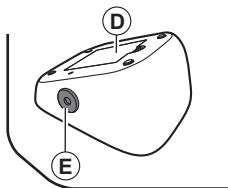

- Ⓓ Battery compartment
- Ⓔ Air jack



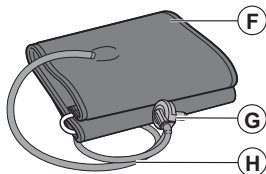

Arm cuff:



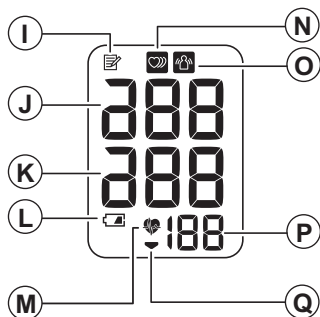



- Ⓕ Arm cuff
(Arm circumference 9" - 17" (22 - 42 cm))
- Ⓖ Air plug
- Ⓗ Air tube

1.1 Display and Symbols



I		Memory symbol Appears when viewing readings stored in the memory.
J	Systolic blood pressure reading	
K	Diastolic blood pressure reading	
L		Low battery symbol Flashes when batteries are low.
		Depleted battery symbol Appears when batteries are depleted.
M		Heartbeat symbol Flashes while taking a measurement.

<p>Ⓝ</p>		<p>Irregular heartbeat symbol</p> <p>Appears along with readings when an irregular rhythm is detected 2 or more times during a measurement.</p> <p>An irregular heartbeat rhythm is defined as a rhythm that is 25% less or 25% more than the average rhythm detected while your monitor is measuring blood pressure.</p> <p>Irregular heartbeat symbol may be displayed when the monitor detects arm movements. Refer to section 4 for more information.</p> <p>If it continues to appear, we recommend you to consult with and follow the directions of your physician.</p> <div style="text-align: center;">  <p>Irregular Heartbeat Short Long</p> <p>Normal Heartbeat</p> </div>
<p>Ⓞ</p>		<p>Movement error symbol</p> <p>Appears with your reading when your body is moving during a measurement. If it appears, remove the arm cuff and wait for 2 to 3 minutes. Then, reapply the cuff, remain still and take another measurement.</p>
<p>Ⓟ</p>	<p>Pulse display / Memory number</p> <p>Pulse rate appears after the measurement.</p>	
<p>Ⓠ</p>		<p>Deflation symbol</p> <p>Appears during cuff deflation.</p>

Classification of BP (Blood Pressure)

ACC/AHA 2017 Hypertension guidelines define categories of BP in adults as below.

Categories of BP in Adults*

BP Category	Systolic BP	Diastolic BP
Normal	< 120 mmHg	and < 80 mmHg
Elevated	120-129 mmHg	and < 80 mmHg
Hypertension		
Stage 1	130-139 mmHg	or 80-89 mmHg
Stage 2	≥ 140 mmHg	or ≥ 90 mmHg

* Individuals with Systolic BP and Diastolic BP in 2 categories should be designated to the higher BP category.

BP indicates blood pressure (based on an average of ≥ 2 careful readings obtained on ≥ 2 occasions).

Source: ACC/AHA 2017 High Blood Pressure Clinical Practice Guideline



Warning

NEVER diagnose or treat yourself based on your readings. ALWAYS consult with your physician.

1.2 Blood Pressure Measurement Tips

To help ensure an accurate reading, follow these directions:

- Stress raises blood pressure. Avoid taking measurements during stressful times.
- Measurements should be taken in a quiet place.
- It is important to take measurements at the same times each day. Taking measurements in the morning and in the evening is recommended.
- Remember to have a record of your blood pressure and pulse readings for your physician. A single measurement does not provide an accurate indication of your true blood pressure. You need to take and record several readings over a period of time.



Caution

- **Avoid bathing, drinking alcohol or caffeine, smoking, exercising and eating for at least 30 minutes before taking a measurement.**
- **Rest for at least 5 minutes before taking a measurement.**

2. Preparation

2.1 Battery Installation

1. Remove the battery cover.

2. Insert 4 “AA” batteries as indicated in the battery compartment.

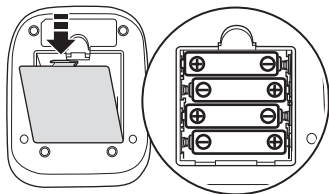

3. Replace the battery cover.

Notes:

- When the low battery symbol () appears on the display, turn the monitor off, then replace all batteries at the same time. Long life alkaline batteries are recommended.
- The measurement values continue to be stored in memory even after the batteries are replaced.
- Disposal of used batteries should be carried out in accordance with local regulations.

3. Using the Monitor

3.1 Applying the Arm Cuff



Caution

Remove tight-fitting, thick clothing from your arm while taking a measurement.

1. Insert the air plug into the air jack securely.

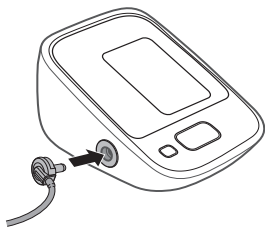

2. Place your hand through the cuff loop, then pull the cuff until it reaches your upper left arm.

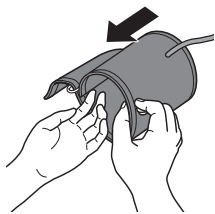

The bottom edge of the arm cuff should be 0.5 inch (1 to 2 cm) above the elbow. Air tube is on the inside of your arm and aligned with your middle finger.

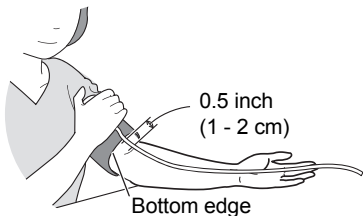

3. Secure closed with the fabric fastener.

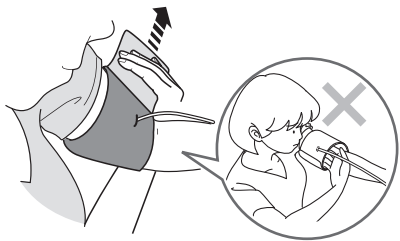

Notes:

- When you take a measurement on the right arm, the air tube will be at the side of your elbow. Be careful not to rest your arm on the air tube.
- The blood pressure can differ between the right arm and the left arm, and the measured blood pressure values can be different. OMRON recommends to always use the same arm for measurement. If the values between both arms differ substantially, please check with your physician which arm to use for your measurements.



3.2 How to Sit Correctly

To take a measurement, you need to be relaxed and comfortably seated with a comfortable room temperature. Place your arm on the table.

- Sit in a comfortable chair with your back and arm supported.
- Keep your feet and your legs uncrossed.
- The arm cuff should be placed on your arm at the same level as your heart, with the arm resting comfortably on a table.

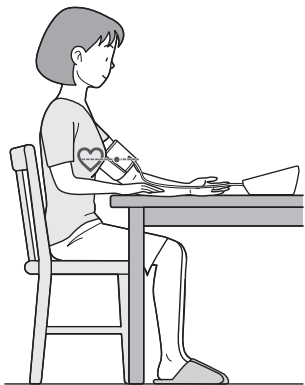

3.3 Taking a Measurement

Notes:

- To stop the measurement, press the START/STOP button once to deflate the arm cuff.
- Remain still and quiet while taking a measurement.

1. Press the START/STOP button.

The arm cuff will start to inflate automatically.

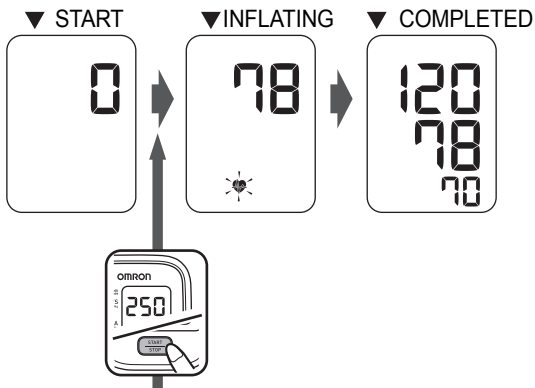

If your systolic pressure is more than 210 mmHg

After the arm cuff starts to inflate, press and hold the START/STOP button until the monitor inflates 30 to 40 mmHg higher than your expected systolic pressure.

Notes:

- The monitor will not inflate above 299 mmHg.



Caution

Inflating to a higher pressure than necessary may result in bruising where the arm cuff is applied.

2. Remove the arm cuff.

3. Press the START/STOP button to turn the monitor off.

The monitor automatically stores the measurement result in its memory. It will automatically turn off after 2 minutes.

Note: Wait 2-3 minutes before taking another measurement. Waiting between measurements allows the arteries to return to the condition prior to taking a measurement.

3.4 Using the Memory Function

The monitor automatically stores the results up to 14 sets.

Note: If the memory is full, the monitor will delete the oldest value.

To View the Measurement Values Stored in Memory

1. Press the  button.

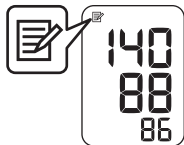

The Memory number appears for a second before the pulse rate is displayed.

The newest set is numbered "1".



2. Press the  button repeatedly to view the values stored in memory.

To Delete All the Values Stored in Memory

1. Press the  button, while the memory symbol appears.
2. While holding the  button down, press the START/STOP button for more than 3 seconds.

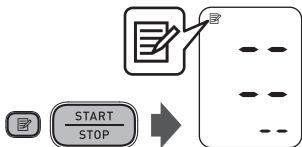





Note: You cannot partially delete the values stored in memory.

4. Error Messages and Troubleshooting

If any of the below problems occur during measurement, check to make sure that no other electrical device is within 12 inches (30 cm).

If the problem persists, refer to the table below.

4.1 Error Messages

Error Display	Cause	Solution
	Irregular heartbeats are detected.	Remove the arm cuff. Wait 2 - 3 minutes and then take another measurement. Repeat the steps in section 3.3. If this error continues to appear, contact your physician.
	Movement during measurement.	Carefully read and repeat the steps in section 3.3.
	The batteries are low.	You should replace the batteries with new ones ahead of time. Refer to section 2.1.
	The batteries are depleted.	You should replace the batteries with new ones at once. Refer to section 2.1.

E1	Air plug disconnected.	Insert the plug securely. Refer to section 3.1.
	Arm cuff is applied too loosely.	Apply the arm cuff tighter. Refer to section 3.1.
	Air is leaking from the arm cuff.	Replace the arm cuff with a new one. Refer to section 5.5.
E2	Movement during measurement and the arm cuff has not been inflated sufficiently.	Repeat measurement. Remain still and do not talk during measurement. Refer to section 3.3.
		If "E2" appears repeatedly, inflate the arm cuff manually until it is 30 to 40 mmHg above your previous measurement result. Refer to section 3.3.
E3	The arm cuff was inflated exceeding the maximum allowable pressure, and then deflated automatically when inflating the arm cuff manually.	Do not touch the arm cuff and/or bend the air tube while taking a measurement. Do not inflate the arm cuff more than necessary. Refer to section 3.3.
E4	Movement during measurement.	Repeat measurement. Remain still and do not talk during measurement. Refer to section 3.3.
E5	Clothing is interfering with the arm cuff.	Remove any clothing interfering with the arm cuff. Refer to section 3.1.

Er	Device error.	Contact Customer Service.
----	---------------	---------------------------

4.2 Troubleshooting

Problem	Cause and Solution
No power. No display appears on the monitor.	Replace all batteries with new ones. Check the battery installation for proper placement of the battery polarities. Refer to section 2.1.
Measurement values appear too high or too low.	Blood pressure varies constantly. Many factors including stress, time of day, and how you wrap the cuff, may affect your blood pressure. Review section 1.2 and section 3.3.

5. Maintenance

5.1 Maintenance

To protect your monitor from damage, please follow the directions below:

- Changes or modifications not approved by the manufacturer will void the user warranty.



Caution

DO NOT disassemble or attempt to repair this monitor or other components. This may cause an inaccurate reading.

5.2 Storage

Store your monitor and other components in a clean, safe location.

1. Remove the arm cuff from the monitor.



Caution

To unplug the air plug, pull on the plastic air plug at the base of the tube, not the tube itself.

2. Gently fold the air tube into the arm cuff.

Note:

- Do not bend or crease the air tube excessively.

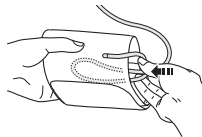

Do not store your monitor and other components:

- If your monitor and other components are wet.
- In locations exposed to extreme temperatures, humidity, direct sunlight, dust or corrosive vapors such as bleach.
- In locations exposed to vibrations or shocks.

5.3 Cleaning

- Do not use any abrasive or volatile cleaners.
- Use a soft dry cloth or a soft cloth moistened with neutral soap to clean your monitor and arm cuff, and then wipe them with a dry cloth.
- Do not wash or immerse your monitor and arm cuff or other components in water.
- Do not use gasoline, thinners or similar solvents to clean your monitor and arm cuff or other components.

5.4 Disposal

- Dispose of your monitor, other components and optional accessories according to applicable local regulations.
- Unlawful disposal may cause environmental pollution.

5.5 Optional Medical Accessories

Arm circumference
7" - 9" (17 - 22 cm)



CD-CS9
(Model: HEM-CS24)

Arm cuff

Arm circumference
9" - 17" (22 - 42 cm)



CD-WR17
(Model: HEM-RML31)



6. Specifications

Model	BP7100CAN REF HEM-7121-CA2
Display	LCD digital display
Cuff pressure range	Pressure: 0 to 299 mmHg
Measurement range	Pressure: 20 to 280 mmHg Pulse: 40 to 180 beats / min.
Accuracy	Pressure: ± 3 mmHg Pulse: $\pm 5\%$ of display reading
Inflation	Fuzzy-logic controlled by electric pump
Deflation	Automatic pressure release valve
Measurement method	Oscillometric method
IP classification	IP 20
Rating	DC6 V 4 W
Power source	4 "AA" batteries 1.5 V
Battery life	Approximately 1000 measurements (using new alkaline batteries)
Durable period (Service life)	Monitor: 5 years Cuff: 5 years
Operating conditions	+50 °F to +104 °F (+10 °C to +40 °C) / 15 to 90% RH (non-condensing) / 800 to 1060 hPa
Storage / Transport conditions	-4 °F to +140 °F (-20 °C to +60 °C) / 10 to 90% RH (non-condensing)
Weight	Monitor : Approximately 8.8 oz. (250 g) not including batteries Arm cuff : Approximately 6 oz. (170 g)
Dimensions	Monitor : Approximately 4.0" (w) \times 3.1" (h) \times 5.1" (l) (103 mm \times 80 mm \times 129 mm) Arm cuff : Approximately 5.7" \times 23.4" (air tube: 29.5") (145 mm \times 594 mm (air tube: 750 mm))
Cuff circumference applicable to the monitor	7" to 17" (170 to 420 mm) (included arm cuff 9" to 17" (220 to 420 mm))
Memory	Up to 14 Readings
Contents	Monitor, arm cuff, instruction manual, quick start guide
Applied part	Type BF (arm cuff)
Protection against electric shock	Internally powered ME equipment

Notes:

- These specifications are subject to change without notice.
- This monitor complies with the requirements of ISO 81060-2:2013. In the clinical validation study, K5 was used on 85 subjects for determination of diastolic blood pressure.
- This monitor has not been validated for use on pregnant patients.
- IP classification is degrees of protection provided by enclosures in accordance with IEC 60529. This monitor is protected against solid foreign objects of 12.5 mm diameter and greater such as a finger.

Pictogram on the Product

 <p>ART.</p>	Type of marks used to indicate the correct positioning of the artery for the upper arm
	Identifies the type of cuff that is compatible with the blood Pressure Monitor

7. FCC/ISED Statement

FCC CAUTION

Changes or modifications not expressly approved by the party responsible for compliance could void the user's authority to operate the equipment.

This device complies with part 15 of FCC Rules and Innovation, Science and Economic Development Canada's licence-exempt RSS(s). Operation is subject to the following two conditions: (1) this device may not cause harmful interference, and (2) this device must accept any interference received, including interference that may cause undesired operation.

Note:

This equipment has been tested and found to comply with the limits for a Class B digital device, pursuant to part 15 of the FCC Rules. These limits are designed to provide reasonable protection against harmful interference in a residential installation. This equipment generates, uses and can radiate radio frequency energy and, if not installed and used in accordance with the instructions, may cause harmful interference to radio communications. However, there is no guarantee that interference will not occur in a particular installation. If this equipment does cause harmful interference to radio or television reception, which can be determined by turning the equipment off and on, the user is encouraged to try to correct the interference by one or more of the following measures:

- Reorient or relocate the receiving antenna.
- Increase the separation between the equipment and receiver.
- Connect the equipment into an outlet on a circuit different from that to which the receiver is connected.
- Consult the dealer or an experienced radio/TV technician for help.

8. Limited Warranty

Your BP7100CAN Automatic Blood Pressure Monitor, excluding the arm cuff, is warranted to be free from defects in materials and workmanship appearing within 2 years from the date of purchase, when used in accordance with the instructions provided with the monitor. The arm cuff is warranted to be free from defects in materials and workmanship appearing within 1 year from the date of purchase when the monitor is used in accordance with the instructions provided with the monitor. The above warranty extends only to the original retail purchaser. We will, at our option, replace without charge any monitor or arm cuff covered by the above warranty. Replacement is our only responsibility and your only remedy under the above warranty.

To obtain warranty service contact Customer Service by calling **1-800-634-4350** for the address of the inspection center and the return shipping and handling fee that may apply.

Enclose the original printed receipt. Include a letter, with your name, address, phone number, and description of the specific problem. Pack the product carefully to prevent damage in transit. Because of possible loss in transit, we recommend insuring the product with return receipt requested.

THE FOREGOING IS THE SOLE WARRANTY PROVIDED BY OMRON IN CONNECTION WITH THIS PRODUCT, AND OMRON HEREBY DISCLAIMS ANY OTHER WARRANTIES, EXPRESS OR IMPLIED, INCLUDING IMPLIED WARRANTIES OF MERCHANTABILITY AND FITNESS FOR A PARTICULAR PURPOSE. IMPLIED WARRANTIES AND OTHER TERMS THAT MAY BE IMPOSED BY LAW, IF ANY, ARE LIMITED IN DURATION TO THE PERIOD OF THE ABOVE EXPRESS WARRANTY.

SOME STATES DO NOT ALLOW LIMITATIONS ON HOW LONG AN IMPLIED WARRANTY LASTS, SO THE ABOVE LIMITATION MAY NOT APPLY TO YOU.

OMRON SHALL NOT BE LIABLE FOR LOSS OF USE OR ANY OTHER SPECIAL, INCIDENTAL, CONSEQUENTIAL OR INDIRECT COSTS, EXPENSES OR DAMAGES.

SOME STATES DO NOT ALLOW THE EXCLUSION OR LIMITATION OF INCIDENTAL OR CONSEQUENTIAL DAMAGES, SO THE ABOVE LIMITATION OR EXCLUSION MAY NOT APPLY TO YOU.

This warranty provides you with specific legal rights, and you may have other rights that vary by jurisdiction. Because of special local requirements, some of the above limitations and exclusions may not apply to you.

FOR CUSTOMER SERVICE

Visit our web site at:

www.OmronHealthcare.ca

Call toll free:

1-800-634-4350

9. Guidance and Manufacturer's Declaration

OMRON Battery-operated Blood Pressure Monitor
Information for Accompanying Documents in the Scope of
IEC60601-1-2:2014

Important information regarding Electromagnetic Compatibility (EMC)

BP7100CAN conforms to IEC60601-1-2:2014 Electromagnetic Compatibility (EMC) standard.

Further documentation in accordance with this EMC standard is available at OmronHealthcare.ca/emc. Refer to the EMC information for BP7100CAN on the website.



OMRON HEALTHCARE Co., Ltd.
53, Kunotsubo, Terado-cho, Muko, Kyoto, 617-0002 JAPAN

Distributed by:
OMRON HEALTHCARE, INC.
1925 West Field Court, Lake Forest, IL 60045 U.S.A.

OmronHealthcare.ca
© 2019 OMRON HEALTHCARE, INC.

Made in Vietnam

2881878-0A